

## Features

- Glass Passivated Bridge Rectifier
- Excellent High Temperature Stability
- 150°C Operating Junction Temperature
- **Lead-Free Finish; RoHS Compliant (Notes 1 & 2)**
- **Halogen and Antimony Free. "Green" Device (Note 3)**

## Mechanical Data

- Case: T-MiniDIP
- Case Material: Molded Plastic "Green" Molding Compound, UL Flammability Classification Rating 94V-0
- Moisture Sensitivity: Level 1 per J-STD-020
- Terminals: Finish – Matte Tin over Copper Lead Frame, Solderable per MIL-STD-202, Method 208
- Polarity: See Diagram
- Weight: 0.092 grams (approximate)

T-MiniDIP

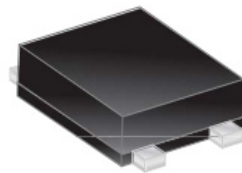

Top View

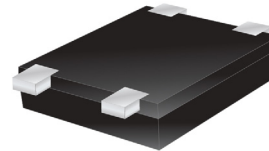

Bottom View

## Ordering Information (Note 4)

Part Number	Case	Packaging
DSRHD02-13	T-MiniDIP	5000/Tape & Reel
DSRHD04-13	T-MiniDIP	5000/Tape & Reel
DSRHD06-13	T-MiniDIP	5000/Tape & Reel
DSRHD08-13	T-MiniDIP	5000/Tape & Reel

- Notes:
1. EU Directive 2002/95/EC (RoHS) & 2011/65/EU (RoHS 2) compliant. All applicable RoHS exemptions applied.
  2. See <http://www.diodes.com> for more information about Diodes Incorporated's definitions of Halogen- and Antimony-free, "Green" and Lead-free.
  3. Halogen- and Antimony-free "Green" products are defined as those which contain <900ppm bromine, <900ppm chlorine (<1500ppm total Br + Cl) and <1000ppm antimony compounds.
  4. For packaging details, go to our website at <http://www.diodes.com>.

## Marking Information



Dxx = Product Type Marking Code

- 12 = 200V
- 14 = 400V
- 16 = 600V
- 18 = 800V

D = Manufacturers' Code Marking

YWW = Date Code Marking

Y = Last Digit of Year (ex: 2 = 2012)

WW = Week Code (01 ~ 53)

**Maximum Ratings** (@T<sub>A</sub> = +25°C, unless otherwise specified.)

Single phase, half wave, 60Hz, resistive or inductive load.  
For capacitance load, derate current by 20%.

Characteristic	Symbol	DSRHD02	DSRHD04	DSRHD06	DSRHD08	Unit
Peak Repetitive Reverse Voltage	V <sub>RRM</sub>	200	400	600	800	V
Working Peak Reverse Voltage	V <sub>RWM</sub>					
DC Blocking Voltage	V <sub>RM</sub>					
Average Rectified Output Current	I <sub>O</sub>	1.0				A
Non-Repetitive Peak Forward Surge Current 8.3ms Single Half Sine-Wave Superimposed on Rated Load (Per Diode)	I <sub>FSM</sub>	30				A
Minimum Fusing Current Rating (t < 8.3 ms)	I <sup>2</sup> t	3.73				A <sup>2</sup> s

**Thermal Characteristics**

Characteristic	Symbol	Value	Unit
Typical Thermal Resistance Junction to Lead	R <sub>θJL</sub>	25	°C/W
Typical Thermal Resistance Junction to Ambient	On Aluminum Substrate	62.5	°C/W
	On Glass-Epoxy Substrate	80	
Operating and Storage Temperature Range	T <sub>J</sub> , T <sub>STG</sub>	-55 to +150	°C

**Electrical Characteristics** (@T<sub>A</sub> = +25°C, unless otherwise specified.)

Characteristic	Symbol	Max	Unit	Test Condition
Forward Voltage (Per Diode)	V <sub>F</sub>	0.95	V	I <sub>F</sub> = 0.4A, T <sub>J</sub> = +25°C
		1.1		I <sub>F</sub> = 1.0A, T <sub>J</sub> = +25°C
Reverse Current (Note 5) (Per Diode) V <sub>R</sub> = Rated Block Voltage	I <sub>R</sub>	10 150	μA	V <sub>R</sub> = Rated Block Voltage, T <sub>J</sub> = 25°C T <sub>J</sub> = 125°C

Notes: 5. Short duration pulse test used to minimize self-heating effect.

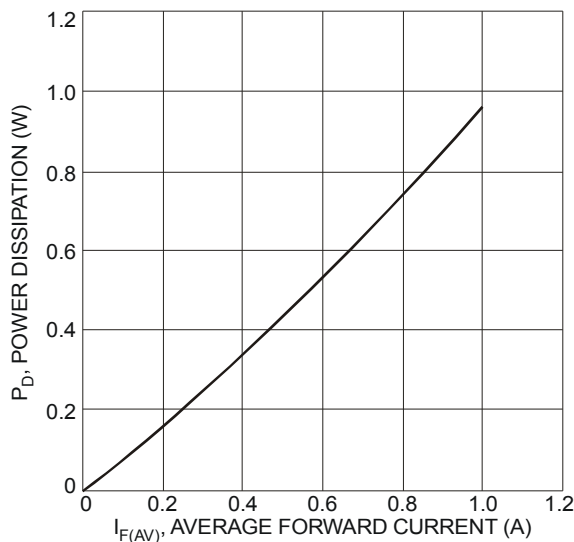

Fig. 1 Forward Power Dissipation

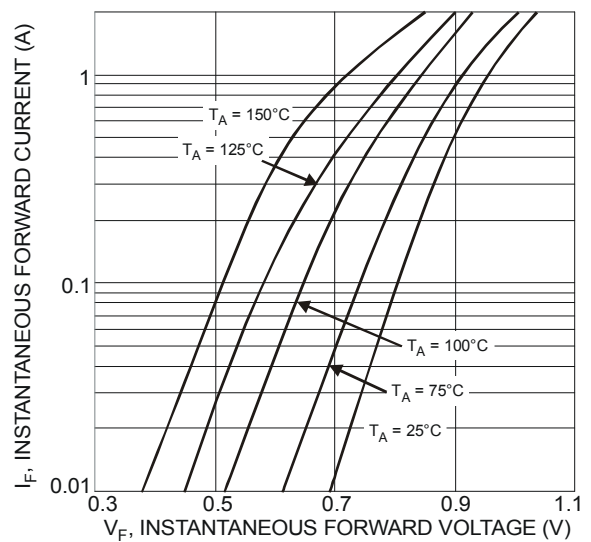
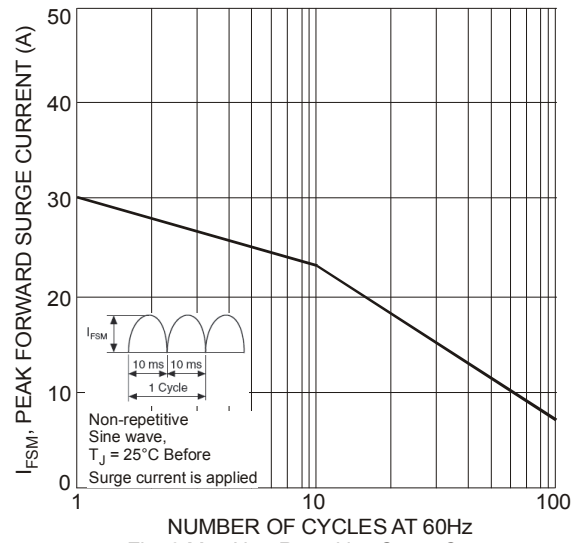
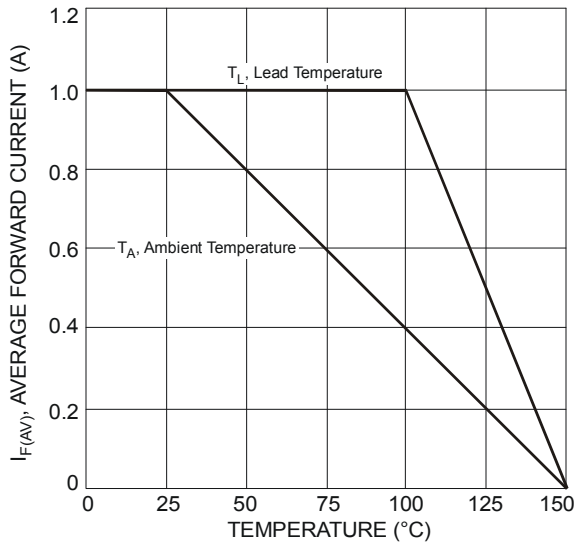
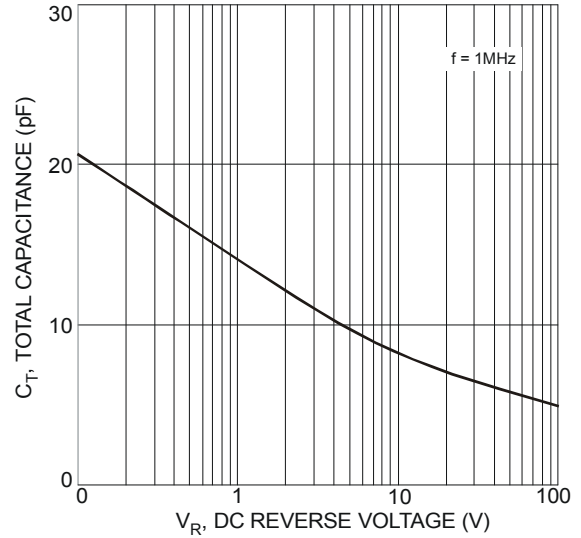
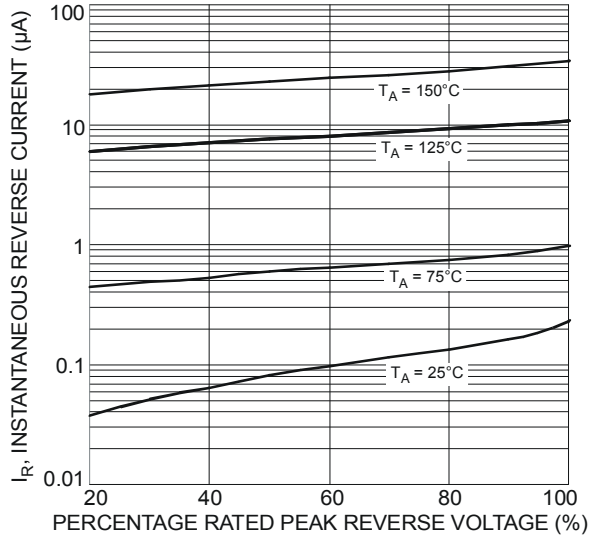
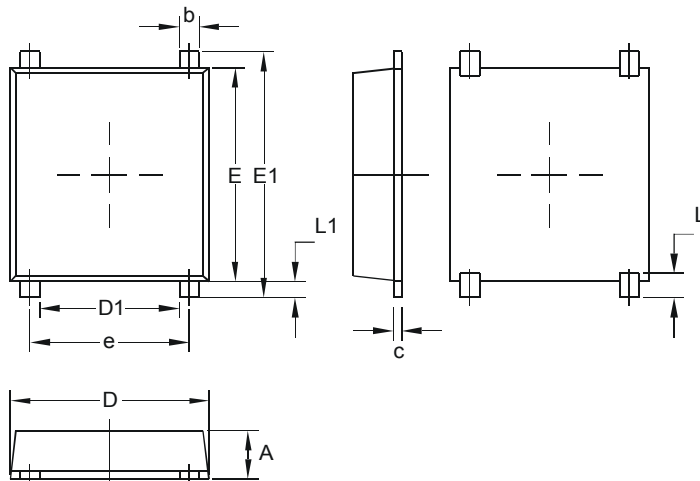

Fig. 2 Typical Forward Characteristics



**Package Outline Dimensions**

Please see AP02002 at <http://www.diodes.com/datasheets/ap02002.pdf> for latest version.



T-MiniDIP		
Dim	Min	Max
A	1.15	1.27
b	0.60	0.70
c	0.15	0.25
D	4.90	5.10
D1	3.20	3.50
E	5.30	5.50
E1	6.00	6.40
e	3.90	4.10
L	0.25	0.80
L1	0.25	0.55
All Dimensions in mm		

**Suggested Pad Layout**

Please see AP02001 at <http://www.diodes.com/datasheets/ap02001.pdf> for the latest version.

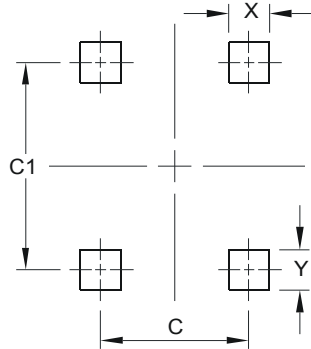

Dimensions	Value (in mm)
<b>C</b>	4.00
<b>C1</b>	5.60
<b>X</b>	0.75
<b>Y</b>	0.85

**IMPORTANT NOTICE**

DIODES INCORPORATED MAKES NO WARRANTY OF ANY KIND, EXPRESS OR IMPLIED, WITH REGARDS TO THIS DOCUMENT, INCLUDING, BUT NOT LIMITED TO, THE IMPLIED WARRANTIES OF MERCHANTABILITY AND FITNESS FOR A PARTICULAR PURPOSE (AND THEIR EQUIVALENTS UNDER THE LAWS OF ANY JURISDICTION).

Diodes Incorporated and its subsidiaries reserve the right to make modifications, enhancements, improvements, corrections or other changes without further notice to this document and any product described herein. Diodes Incorporated does not assume any liability arising out of the application or use of this document or any product described herein; neither does Diodes Incorporated convey any license under its patent or trademark rights, nor the rights of others. Any Customer or user of this document or products described herein in such applications shall assume all risks of such use and will agree to hold Diodes Incorporated and all the companies whose products are represented on Diodes Incorporated website, harmless against all damages.

Diodes Incorporated does not warrant or accept any liability whatsoever in respect of any products purchased through unauthorized sales channel. Should Customers purchase or use Diodes Incorporated products for any unintended or unauthorized application, Customers shall indemnify and hold Diodes Incorporated and its representatives harmless against all claims, damages, expenses, and attorney fees arising out of, directly or indirectly, any claim of personal injury or death associated with such unintended or unauthorized application.

Products described herein may be covered by one or more United States, international or foreign patents pending. Product names and markings noted herein may also be covered by one or more United States, international or foreign trademarks.

This document is written in English but may be translated into multiple languages for reference. Only the English version of this document is the final and determinative format released by Diodes Incorporated.

**LIFE SUPPORT**

Diodes Incorporated products are specifically not authorized for use as critical components in life support devices or systems without the express written approval of the Chief Executive Officer of Diodes Incorporated. As used herein:

- A. Life support devices or systems are devices or systems which:
  - 1. are intended to implant into the body, or
  - 2. support or sustain life and whose failure to perform when properly used in accordance with instructions for use provided in the labeling can be reasonably expected to result in significant injury to the user.
- B. A critical component is any component in a life support device or system whose failure to perform can be reasonably expected to cause the failure of the life support device or to affect its safety or effectiveness.

Customers represent that they have all necessary expertise in the safety and regulatory ramifications of their life support devices or systems, and acknowledge and agree that they are solely responsible for all legal, regulatory and safety-related requirements concerning their products and any use of Diodes Incorporated products in such safety-critical, life support devices or systems, notwithstanding any devices- or systems-related information or support that may be provided by Diodes Incorporated. Further, Customers must fully indemnify Diodes Incorporated and its representatives against any damages arising out of the use of Diodes Incorporated products in such safety-critical, life support devices or systems.

Copyright © 2012, Diodes Incorporated

[www.diodes.com](http://www.diodes.com)